

Article number: 20807019

Description: E+G Spherical washer, female
DIN 6319-19-G

Measures

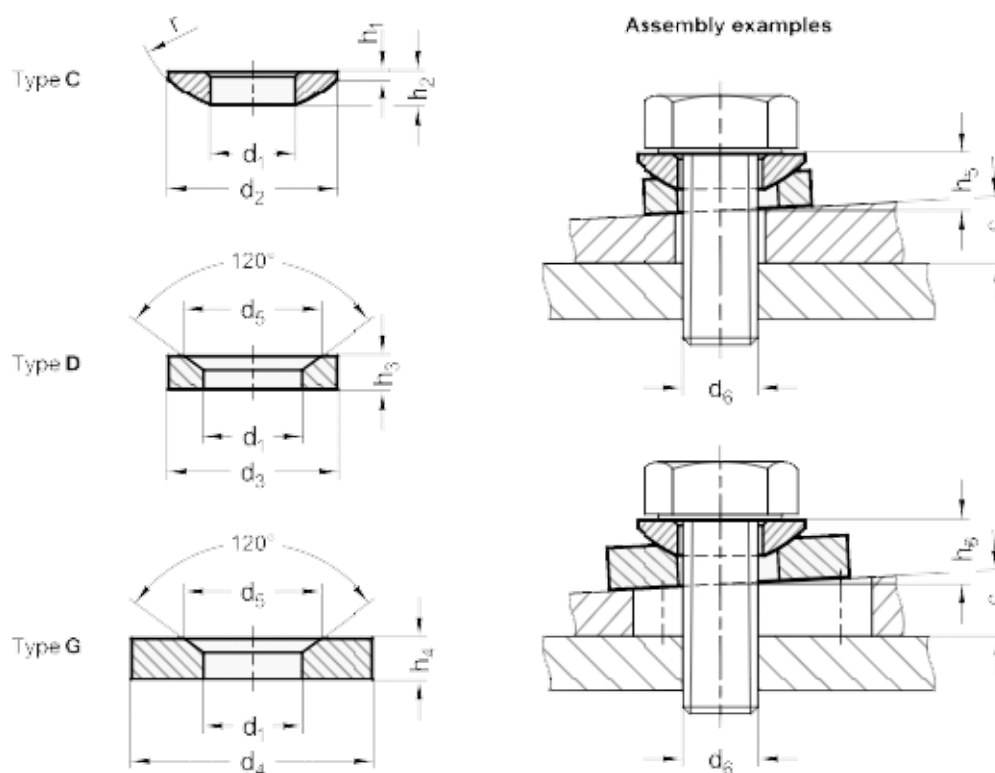

$d_2 = 19.0$

$d_4 = 44$

$d_5 = 26.0$

$d_6 = M16$

$H_3 = 7.0$

$H_4 = 9.6$